

Accu-Scheren / Battery Shears

Accu 45, Serie A / Accu 45, Series A
Accu 60, Serie A / Accu 60, Series A
Accu 75, Serie A / Accu 75, Series A
Accu BS 60, Serie A / Accu BS 60, Series A
Accu BS 45, Serie A / Accu BS 45, Series A
AC-TS Teleskopstiel / AC-TS Vario Handle
AC-R Räder / AC-R wheels

Ausstattung / Specification

Typ / Kurzbez. / short code	Accu 45	Accu 60	Accu 75	Accu BS 60	Accu BS 45
Geräte - Nr. / part No.	7084000	7085000	7086000	7087000	7087005
Ausführung für / version	International				
Zellenanzahl / number of battery cells	3	4	6	6	6
Spannung (V) / voltage (V)	3,6	4,8	7,2	7,2	7,2
Kapazität (ah) / capacity (ah)	1,2	1,2	1,2	1,2	1,2
Messer-Modell, Art.-Nr. / blade modell, part No.	Accu 8 EM 7084095	Accu 8 EM 7084095	Accu 10 EM 7085095	Accu BS EM * 7095095	Accu BS EM ** 7095095
Messer-Schnittbreite (cm) / cutting width (cm)	8	8	10	17	17
Zubehör / optional extras:	Teleskopstiel / Vario Handle AC-TS 7095000 Ersatzräder / replacement wheels AC-R 7084094				

* alternativ Accu 8 EM oder Accu 10 EM

* alternative Accu 8 EM or Accu 10 EM

** incl. Messersatz Accu 8 EM

** incl. replacement blade Accu 8 EM

Achtung: Instandsetzungen an Elektrogeräten dürfen nur von entsprechenden Fachkräften durchgeführt werden !
 Die Isolationswiderstandsmessung / Schutzleiterprüfung gemäß DIN/VDE 0701 Teil 2 ist **nach jeder Reparatur** vorzunehmen.

Attention: Repairs on electrical appliances must only be carried out by qualified specialists !
 The verification of the insulating resistance / protective conductor examination according to DIN/VDE 0701 part 2 **must be carried out after each repair !**

NR:7085 000 Bezeichnung: Accu 60 Gruppe: Accu-Schere Jahr: 02 Typ: A

- Ⓓ **Accu 45, Accu 60, Accu 75, Accu BS 60, Accu BS 45**
Gehäuse, Schalter, Räder
- ⒼⒷ **Accu 45, Accu 60, Accu 75, Accu BS 60, Accu BS 45**
Case, switch, wheels

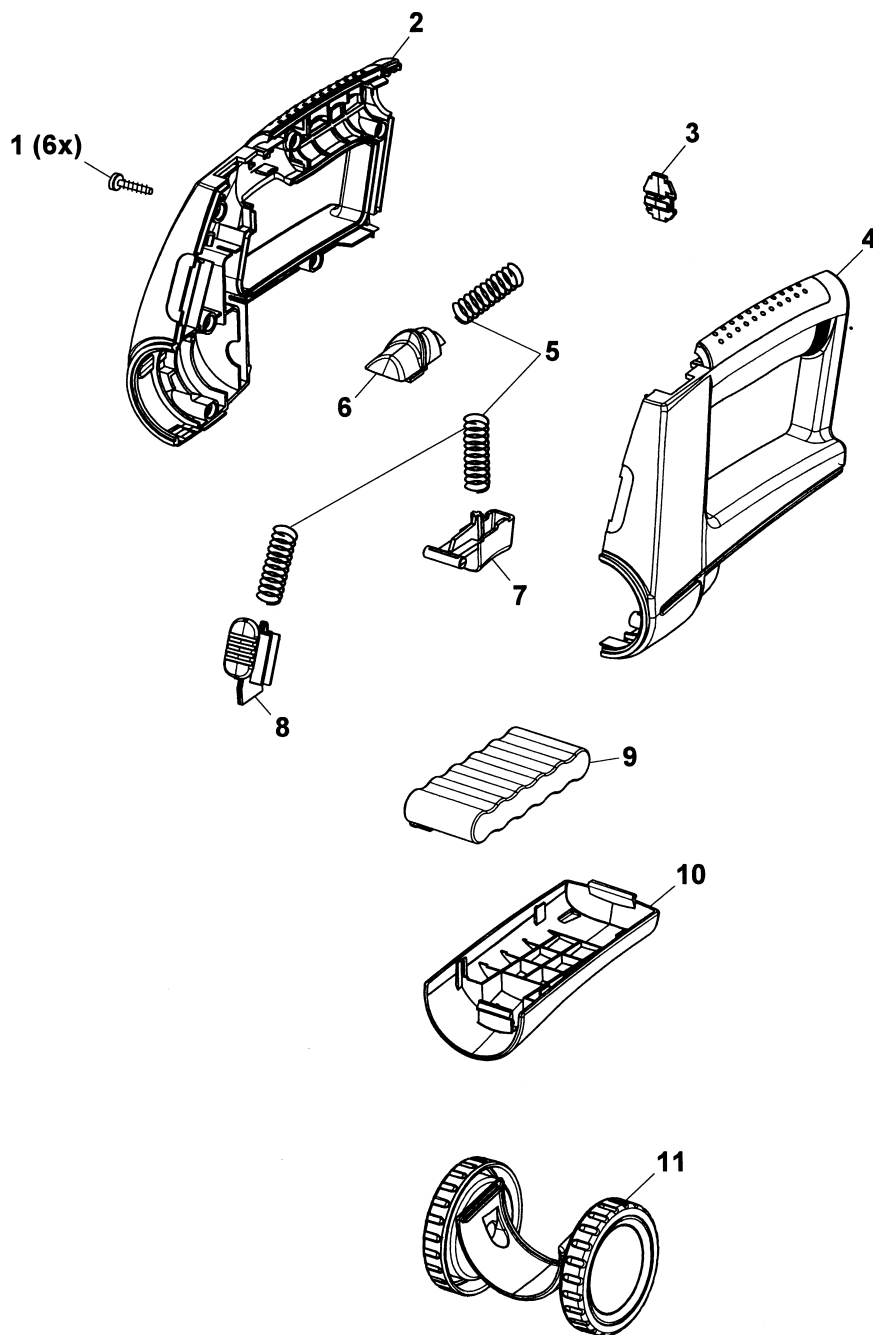

**Accu 45, Accu 60, Accu 75, Accu BS 60, Accu BS 45
Gehäuse, Schalter, Räder
Accu 45, Accu 60, Accu 75, Accu BS 60, Accu BS 45
Case, switch, wheels**

Bild-Nr. / Ref. No.	Best.-Nr. / Part No.	Bezeichnung	Description
1	0012 625	TORX-Schr. K40x16 (6 St.)	screw K40x16 (6 pieces)
2	7084 300	Gehäuse, rechts (Accu 45, Accu 60, Accu BS 45)	case, right hand (Accu 45, Accu 60, Accu BS 45)
	7086 300	Gehäuse, rechts (Accu 75, Accu BS 60)	case, right hand (Accu 75, Accu BS 60)
3	7086 302	Kontakthalter	contact maker
4	7084 035	Gehäuse, links (Accu 45, Accu BS 45)	case, left hand (Accu 45, Accu BS 45)
	7085 035	Gehäuse, links (Accu 60)	case, left hand (Accu 60)
	7086 035	Gehäuse, links (Accu 75)	case, left hand (Accu 75)
	7087 035	Gehäuse, links (Accu BS 60)	case, left hand (Accu BS 60)
5	7086 115	Druckfeder (3 Stück)	compression spring (3 piec.)
6	7086 305	Schaltknopf	push button
7	7086 304	Schalterwippe	switch
8	7086 303	Dreh-Verriegelung	lock (for working position)
9	7084 055	Batteriepaket (Accu 45)	battery (Accu 45)
	7085 055	Batteriepaket (Accu 60)	battery (Accu 60)
	7086 055	Batteriepaket (Accu 75, Accu BS 60, Accu BS 45)	battery (Accu 75, Accu BS 60, Accu BS 45)
10	7086 316	Akkudeckel	battery cover
11	7084 094	Esatzräder (AC-R)	replacement wheels (AC-R)

- Ⓓ **Accu 45, Accu 60, Accu 75, Accu BS 60, Accu BS 45
Drehkopf, Messer, Motor**
- ⒼⒷ **Accu 45, Accu 60, Accu 75, Accu BS 60, Accu BS 45
Rotatable head, blade, motor**

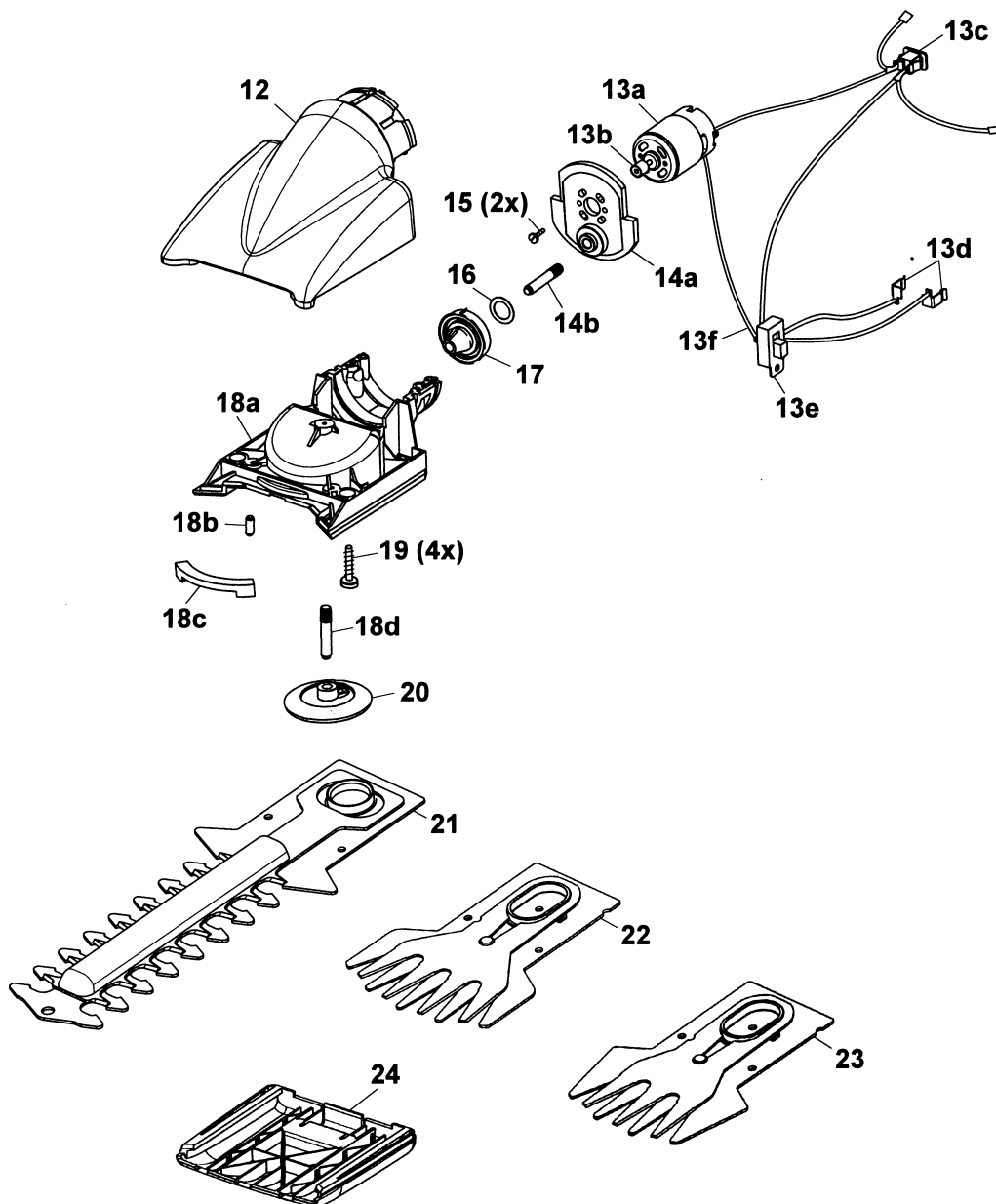

Accu 45, Accu 60, Accu 75, Accu BS 60, Accu BS 45
Drehkopf, Messer, Motor
Accu 45, Accu 60, Accu 75, Accu BS 60, Accu BS 45
Rotatable head, blade, motor

Bild-Nr. / Ref. No.	Best.-Nr. / Part No.	Bezeichnung	description
12	7086 310	Haube	hood
13a		Motor	motor
13b		Motorritzel	pinion drive (motor)
13c		Ladebuchse	connection - battery charger
13d		Schalterkontakte	switching contacts
13e		Schiebeschalter	sliding switch
13f		Kabelbaum	cable form
***	7085 054	Motor, kpl. 3,6-4,8 V (Accu 45, Accu 60)	motor, compl., 3,6-4,8 V (Accu 45, Accu 60)
***	7086 054	Motor, kpl. 7,2 V (Accu 75, Accu BS 60, Accu BS 45)	motor, compl., 7,2 V (Accu 75, Accu BS 60, Accu BS 45)
14a		Motorplatte	motor support
14b		Zahnradachse	long-face pinion
***	7086 910	Motorplatte kpl.	motor support compl.
15	0012 229	Zylinderschr. M2, 6x6 (2 St.)	cheese head screw (2 p.)
16	0017 042	Scheibe Ø10+Ø16+0,3	washer 10 dia.+16 dia.+0,3
17	7086 313	Stirnrad	cylinder gear

Accu 45, Accu 60, Accu 75, Accu BS 60, Accu BS 45
Drehkopf, Messer, Motor
Accu 45, Accu 60, Accu 75, Accu BS 60, Accu BS 45
Rotatable head, blade, motor

Bild-Nr. / Ref. No.	Best.-Nr. / Part No.	Bezeichnung	description
18a		Getriebegehäuse	gearbox case
18b		Bolzen Ø 4 + 10 (2 Stück)	bolt 4 + 10 dia. (2 pieces)
18c	7086 318	Dichtleiste	sealing lip
18d		Zahnradachse	long-face pinion
***	7086 911	Getriebegehäuse kpl.	gearbox case compl.
19	0012 625	TORX-Schr. K40x16 (6 St.)	screw K40x16 (6 pieces)
20	7086 312	Tellerrad	plate
21	7095 095	Strauchmesser (Accu BS EM) <u>nur für:</u> Accu 60, Accu 75, Accu BS 60, Accu BS 45	replac. blade (Accu BS EM) <u>only</u> Accu 60, Accu 75, Accu BS 60, Accu BS 45
22	7085 095	Scherenblatt (Accu 10 EM)	replac. blade (Accu 10 EM)
23	7084 095	Scherenblatt (Accu 8 EM)	replac. blade (Accu 8 EM)
24	7086 311	Gleitkufe	blade cover
***	7086 078	Ladegerät	battery charger
***	0054 199	Gebrauchsanweisung D, GB, F, I, NL	instruction manual only D, GB, F, I, NL
***	0054 222	Gebrauchsanweisung DK, N, S, FIN, CZ, PL, H	instruction manual DK, N, S, FIN, CZ, PL, H

- Ⓓ 7095 000 AC-TS Teleskopstiel
- ⒼⒷ 7095 000 AC-TS Vario Handle

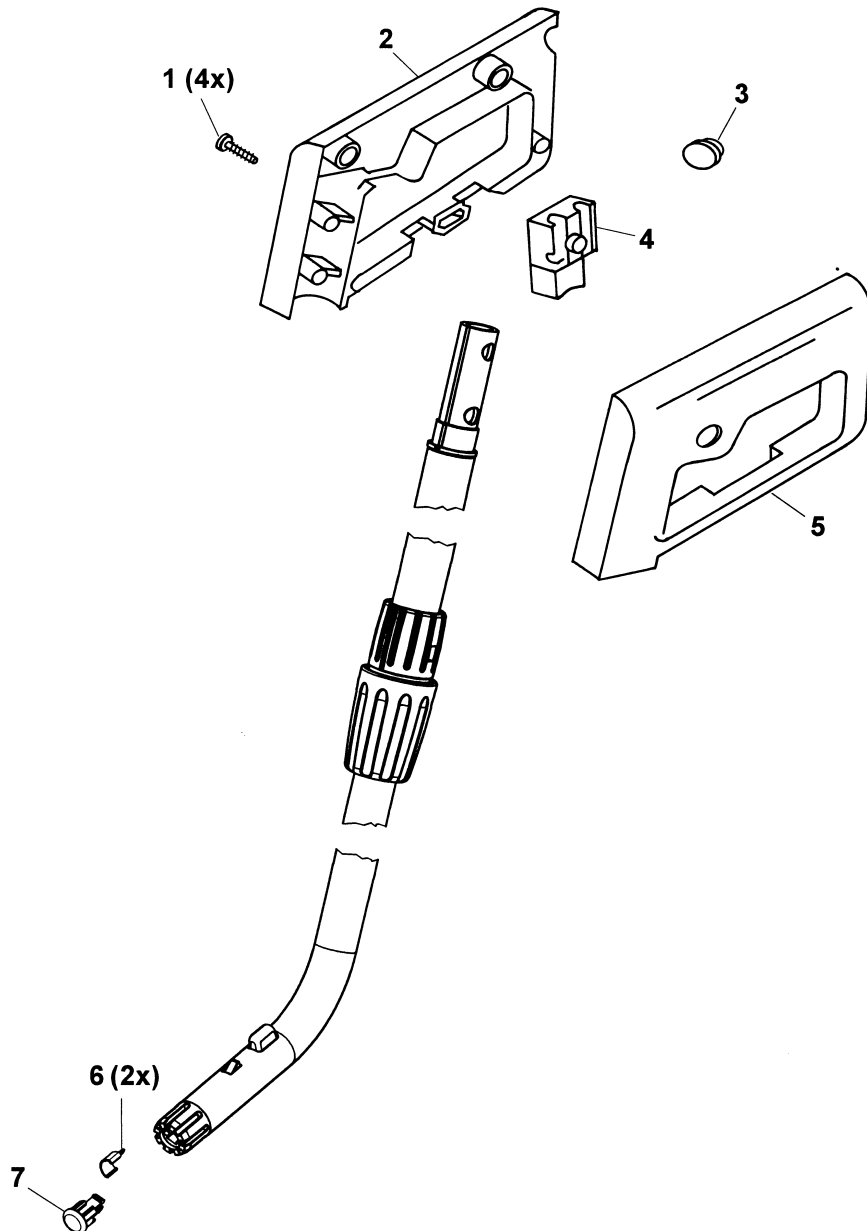

7095 000 AC-TS Teleskopstiel
7095 000 AC-TS Vario Handle

Bild-Nr. / Ref. No.	Best.-Nr. / Part No.	Bezeichnung	description
1	0012 625	TORX-Schraube K40x16 (4 Stück)	screw K40x16 (4 pieces)
2	7126 335	Obergriff, rechts	handle, right hand
3	7095 316	Verschlussdeckel	plug
4	7095 101	Druckknopfschalter	switch
5	7095 036	Obergriff, links	handle, left hand
6	7095 100	Stielkontakt (2 Stück)	contact Vario Handle
7	7095 313	Kappe	cap